

# SYLVANIX COMPOSITE DECKING INSTALLATION GUIDE

---



## Table of Contents

Tools Required .....	2	TC-G Hidden Fastener Installation .....	6
Jobsite Storage .....	2	Alternative Hidden Fastener Installation.....	8
Expansion and Spacing Considerations .....	4	Fascia Installation .....	9
End-to-end Spacing by Ambient Temperature .....	4	Rooftop and Sleeper Deck Systems .....	10
Face Fastener.....	5		

## IMPORTANT: Please read all sections before you install your deck.

### Tools Required

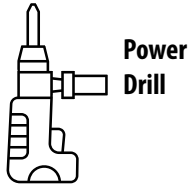

Power  
Drill



1/8 in. (3.2 mm)  
Countersinking  
Drill Bit

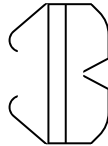

Safety  
Goggles

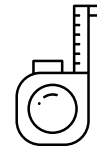

Measuring  
Tape



Torpedo  
Level

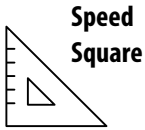

Speed  
Square

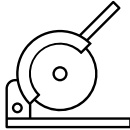

Miter Saw  
Use composite specific  
of finish blade for  
best results.



Pencil

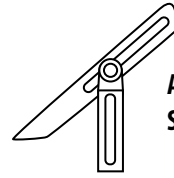

Adjustable  
Square

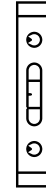

Minimum  
4 ft. (122 mm)  
Level

### Job Site Storage

Store decking on a flat level surface supported every 24". DO NOT store directly on the ground. Supports (dunnage) should start no more than 9 inches from each end. In addition, supports be perpendicular to the decking product. If stacking multiple units it is critical that the supports line up vertically down through each stack. ALWAYS cover decking products on site or store in the shade until ready to be installed.

### Airflow and Drainage

Make sure there is adequate and unobstructed air flow under 50% of the deck perimeter to allow for cross-ventilation. This is not only to promote dryness, but also to negate heat buildup beneath the deck. Allow a minimum of 1.5 in. (38.1 mm) between the bottom of the joists and the ground or existing surface. Water must be able to flow away from under the deck. Improve drainage or grade flat areas where standing water may gather. Do not install decking directly to an existing or solid surface.

Sleeper installation: Minimum joist height is 1.5 in. (38.1 mm), installed level, in the direction of water runoff and directly to a solid sub-structure. Create

adequate cross-ventilation for the deck by widening side-to-side spacing between boards to 1/4 in. (6.4 mm) with a maximum of 3/8 in. (9.5 mm) gap. The deck design must allow for a minimum of 1.5 in. (38.1 mm) of unrestricted air flow under the deck at the open joist ends for cross-ventilation and drainage.

Under-deck waterproofing systems, properly installed, can provide additional living or storage space. Improper installations are those that restrict air flow and result in buildup of heat and/or humidity, which can result in unwanted consequences. Follow all previous airflow and drainage requirements.

## Pre Installation

**IMPORTANT:** Follow local applicable building codes. Careful planning of the finished deck layout will result in more pleasing finished projects. Wear safety equipment and use caution with power tools. Failure to follow installation guidelines could void the warranty.

**NOTE:** The use of self adhesive flashing such as Grace Vycor or other comparable self-adhesive flashings extends the life of the joists beneath the decking when applied properly. Without the use of

flashing on the joists it is possible that the joists useable life could be reached before it is necessary to replace the Sylvanix decking surface.

**CAUTION:** Sources of heat and heat buildup can potentially damage Sylvanix decking surfaces. Examples include wood burning fire pits, charcoal BBQ's, light reflected from windows and glass doors, and under-deck waterproofing installations that does not provide adequate ventilation.

## Code Compliance

**WARNING:** Sylvanix decking is not to be used for structural applications, it is deck surfaces only.

### Joist Spanning for Decking

Sylvanix decking meets all applicable national model building codes. The joists must be spaced according to the chart below. Take care to ensure that joists are level and plumb. Sylvanix decking must span at least three joists. For heavy items such as hot tubs, planters, etc., consult a local building engineer or inspector for span recommendations.

### Code Listings

Sylvanix complies with major model building codes and has been evaluated by the International Code Council evaluation service.

## Sylvanix Decking Span Chart (Joist Spacing)

	Residential Applications and Light Duty Docks	Commercial Applications	Stairs
Decking Loading	100 psf = 4.8 kN/m <sup>2</sup>	100 psf = 4.8 kN/m <sup>2</sup> 200 psf = 9.5 kN/m <sup>2</sup>	300 psf = 14.4 kN/m <sup>2</sup>
Sylvanix Decking	16" (406.4 mm)*	12" (304.8 mm)* 16" (406.4 mm)*	11" (279.4 mm)*

\* Reduce joist spacing by 4" if installing decking at a 45 degree angle.

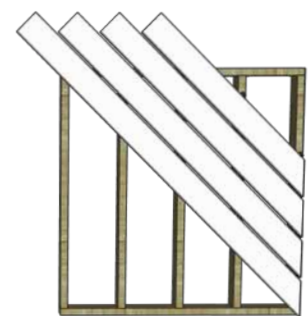

45 degree installation

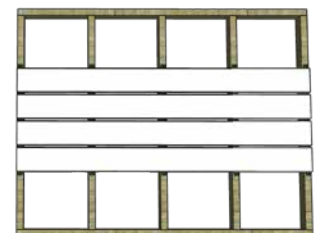

90 degree installation

## Expansion and Spacing Considerations

All decking materials, whether wood, composite, or metal, undergo some degree of linear expansion with the change of weather and the seasons. For best spacing results, keep boards out of direct sun during storage and cutting processes and throughout installation, if possible. To compensate for the effects of contraction and expansion, use short boards (where possible) with splitter/divider boards between each continuous run of boards.

Adequate board spacing of a minimum 3/16 in. (4.8 mm) between board sides will provide proper drainage and ventilation and assist with the removal of small organic debris. Allow a minimum of 1/4 in. (6.4 mm) spacing between boards and any permanent structure.

Spacing requirements must be met for full Sylvania warranty coverage. End-to-side spacing recommendations are determined by the temperature at 1/8 in. for temperatures below 70°F, or 1/16 in. for temperatures above 70°F.

## End-to-end Spacing By Installation Ambient Temperature

	35° and under	36° - 69°	70° - 89°	90° - 109°	110° and up
<b>Sylvanix</b>	1/4 in. (6.4 mm)	3/16 in. (4.8 mm)	1/8 in. (3.2 mm)	1/16 in. (1.6 mm)	1/32 in. (0.8 mm)

**NOTE:** On decking runs over 30' it is recommended to “picture frame the decking” to minimize the impact of expansion and contraction and the possible movement of boards over time. See technical bulletin on the Sylvania website.

**NOTE:** Should board temperature be higher than the ambient air temperature decrease end-to-end spacing accordingly.

**NOTE:** In areas where extreme temperature swings are prevalent, adding 2X blocking at butt joints is recommended.

## Face Fastener Installation

All Sylvanix Outdoor Products decking may be face/surface fastened. Use only screws specifically designed for composite decking.

For best results, use either minimum #10 x 2.5 in. stainless steel composite deck screws, or Cortex® hidden fasteners. Screws not designed for composite decking may cause damage to the boards.

### STANDARD SCREWS MAY CAUSE DAMAGE TO THE DECKING



Standard Screw



Composite Deck Screw

Composite decking screws are specially designed not to mushroom around the fastener head. They help create a tight bond to the joist connection and produce a clean, finished look that is smooth and barefoot-friendly.

1. Install two screws at each joist on every deck board. It is required to predrill using a 1/8 in. (3.2 mm) countersinking drill bit for all face fastener installations.
2. Screw heads must be flush with board surface.
3. Sylvanix highly recommends pre drilling and the use of stainless steel composite decking screws. Pre-drilling all holes will result in more pleasing finished projects.
4. Use caution to avoid over-driving fasteners. Backing overdriven fasteners out often causes a mushrooming effect at the decking surface.
5. At board ends place screws a minimum of 1.5" (38.1mm) from the board end and 1" (25.4mm) from the board edge to avoid splitting the board and voiding the Sylvanix Decking warranty.
6. Always drive in surface fasteners at a 90° angle to the decking surface with two fasteners at every joist location. Do not angle screws into the joist.

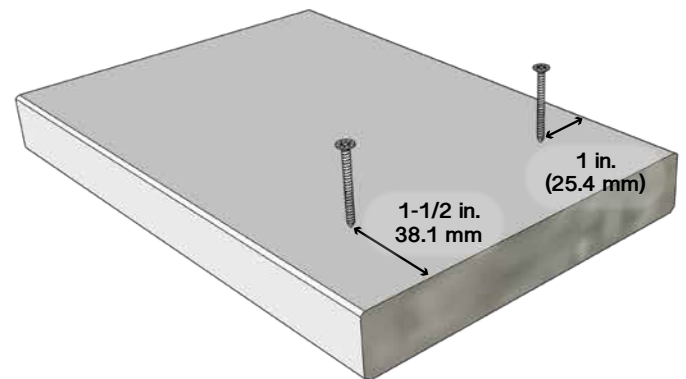

**NOTE:** For butt joints, where boards meet over a single joist, add a 2" x 4" "nailer" board at the butt joint or add an extra joist. This allows for the installation of face screws at 90 degrees per the requirements noted above.

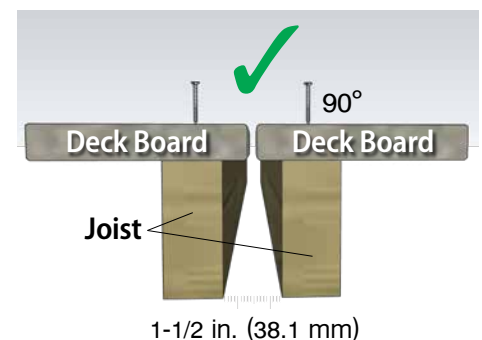
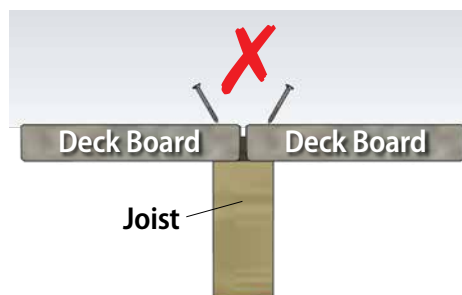

## TC-G Hidden Fastener Installation

**NOTE:** TC-G (TC-150) for use with 1" (25mm) or thicker decking. TC-120 for use with 3/4" (19mm) decking.

### TOOLS & MATERIALS NEEDED



Safety Glasses



Power screw gun with ratcheting torque setting

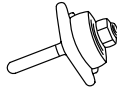

Tiger Claw Slot Cutter



Router

**IMPORTANT!** Read all instructions carefully and completely to ensure proper installation.

**WARNING!** Parts have sharp points & edges. Use extreme caution when handling & installing. Wear safety glasses at all times.

**STEP 1**

### INSTALL FIRST BOARD

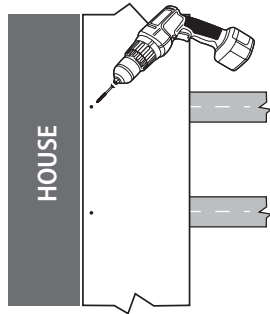

Fasten one edge of the first board at each framing support using a quality 2 1/2" (64mm) deck screw. It is important that this board is straight and well secured.

**STEP 3**

### INSTALL FIRST FASTENER

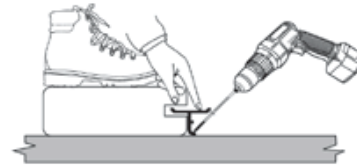

While standing on deck board, install provided screw at 45° angle through fastener. Install one fastener and screw at each support joist.

Make sure fastener body is vertical to deck board and the screw is holding fastener down tight to support joist. Adjust torque setting on screw gun to prevent spin out of the screw head.

**STEP 2**

### POSITION FASTENERS

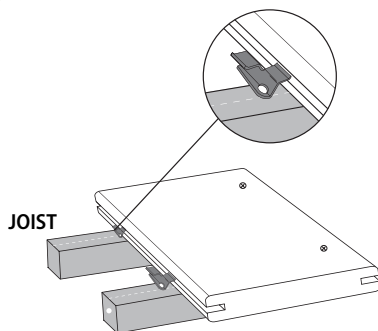

Fully insert TC-G or TC-120 fastener into grooved edge of deck board. Screw hole should line up with the center of support joist.



**STEP 4**

### COMPLETING INSTALLATION OF BOARDS

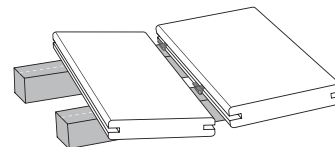

**a** Place next deck board into position against fasteners. Slightly raise outer edge of board being installed and slide board onto fastener until board contacts spacer tabs.

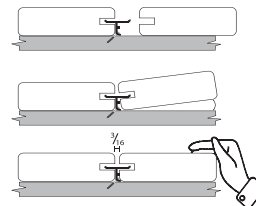

**b** Check gap between boards for consistency. Apply force to ensure board is fully installed.

**Repeat steps 2 - 4 until deck is complete.**

# TC-G Hidden Fastener Installation (cont.)

## HELPPFUL TIPS

### Coverage

- Multiply the number of joists by the number of decking boards to equal the number of fasteners needed.
- 90 fasteners will cover approximately 50 sq. ft. (4.6 m) using 5.5" (140mm) decking boards on 16" (410mm) centers or 35 sq. ft. (3.3 m) using 3.5" (90mm) decking boards on 16" (410mm) on centers.

### How do you attach the last board?

To finish, we recommend using either finish nails or trim screws to secure the last board along its edge. or, you can angle a screw through the deck frame and into the bottom of the deck board.

### 45° Angle Installation

When deck is in the walled corner of the house: always start with small piece of decking in that corner and work your way out. When installing TC Fasteners, offset the center 1/2" (13mm) towards the long point of joist, so screw will not exit side of joist when driven.

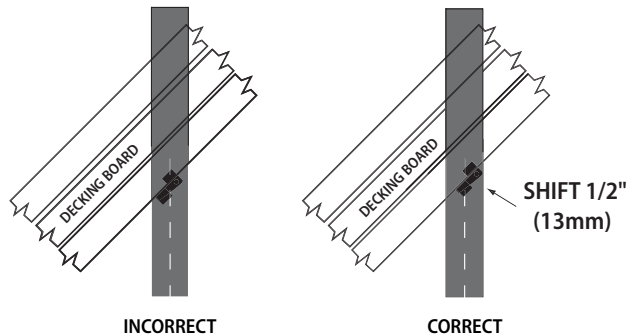

### How to do a butt seam

For TC-G (TC-150): butt seam clip is available to use with the TC-G (TC-150)

For TC-120: first, install a small framing board 10-12" (250-300mm) alongside the joist on which the seam is going to land. install additional fastener into previous board above small framing block. line up your first board in the center of the joist and the small framing board. install fasteners and screw at each joust of the first board including the joist at the seam. then install your second board in the same fashion, and place a second fastener at the seam attaching it to the small framing block. be sure you follow the end-to-end gapping instructions provided by decking manufacturer.

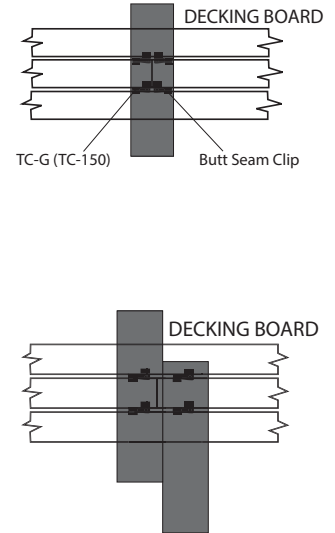

### How to replace a board

- Make two parallel cuts down the center of the board to be replaced, and remove the center piece.
- Using a small pry bar, remove the remaining pieces of decking from the tabs.
- Using a reciprocating saw, remove the tabs on the side of the board with the screw heads showing.
- Position new board into place, and carefully slide onto remaining tabs.
- Once board is set into position, secure the lead edge with finish nail, finish screw, or counter drill, screw and plug.

**To use the TC-G or TC-120 fastener on solid-edge boards** Use a router to create a groove at every intersection of the deck board and support joists, or groove the entire edge of the deck board.



**For TC-G (for use in 1" (25mm) or thicker decking):** Use the Tiger Claw TC-G Slot Cutter to create the groove shown below.

**For TC-120 (for use with 3/4" (19mm) decking):** Use with Tiger Claw TC-120 Slot Cutter to create the grooves shown below.

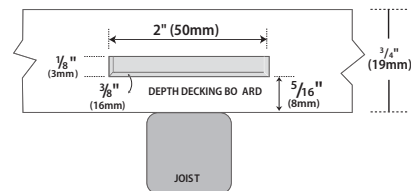
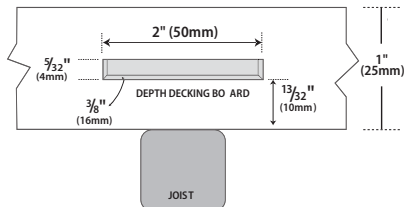

**NOTE:** The groove should start 13/32" (10mm) above the BOTTOM of the deck board. Groove should be at least 7/16" (11mm) deep.

**NOTE:** The groove should start 5/16" (8mm) above the BOTTOM of the deck board. Groove should be at least 7/16" (11mm) deep.

**NOTE:** When using material with expected expansion greater than 1/8" (3mm), in width allow additional spacing between deck boards. (Check with your lumber supplier for expected expansion in your area.

**NOTE:** When using material with expected expansion greater than 1/8" (3mm), in width allow additional spacing between deck boards. (Check with your lumber supplier for expected expansion in your area.

## Alternative Hidden Fastener Installation

**NOTE:** Hidden fasteners must be used at every joist.

### STEP 1

Fasten one edge of the first board at each framing support using composite deck screws. It is important that this board is straight and well secured.

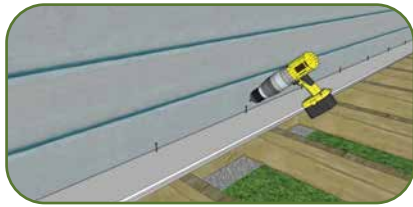

### STEP 2

Fully insert hidden fastener into grooved edge of deck board. Screw hole should line up with the center of support joist.

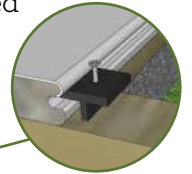
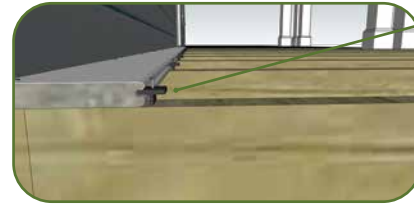

### STEP 3

While standing on deck board, install provided screw at 45° angle through fastener and into joist, while applying pressure on fastener. Install one fastener and screw at each support joist.



### STEP 4

Check gap between boards for consistency. Apply force to ensure board is fully installed. Repeat steps 2 - 4 until deck is complete.

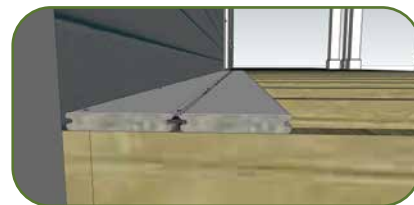
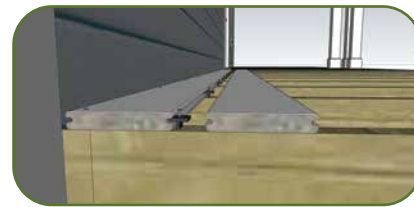

### Routing Square Edge Boards for Hidden Fasteners

**Note:** All square edge profiles except fascia can be routed.

Use a Slotting Cutter Arbor with a 5/32" Slotting Cutter on any standard router. Alternatively you can use a biscuit joiner with a 5/32" cutting bit:

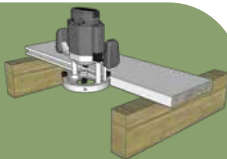

1. Adjust tool to cut slot in the center of board side.
2. Route from the bottom side of board.
3. Route the entire length of the board, or at every intersection where board is over support joists.



## Fascia Installation

For fascia installation, install stainless steel composite deck screws at a maximum 12 inches (304.8 mm) interval. Install three screws spaced vertically across the face at each interval. The use of specialized fascia screws such as Starborn Deckfast® Fascia System provides the best performance results.

The use of hidden fasteners such as Cortex for fascia or riser installation **VOIDS WARRANTY**. For risers install two stainless steel composite deck screws at a maximum 12 inches (304.8 mm) interval spaced vertically across the face at each interval.

Install fasteners flush with board surface. Do not over-tighten screws. For fascia spacing refer to the end-to-end spacing chart on page 4.

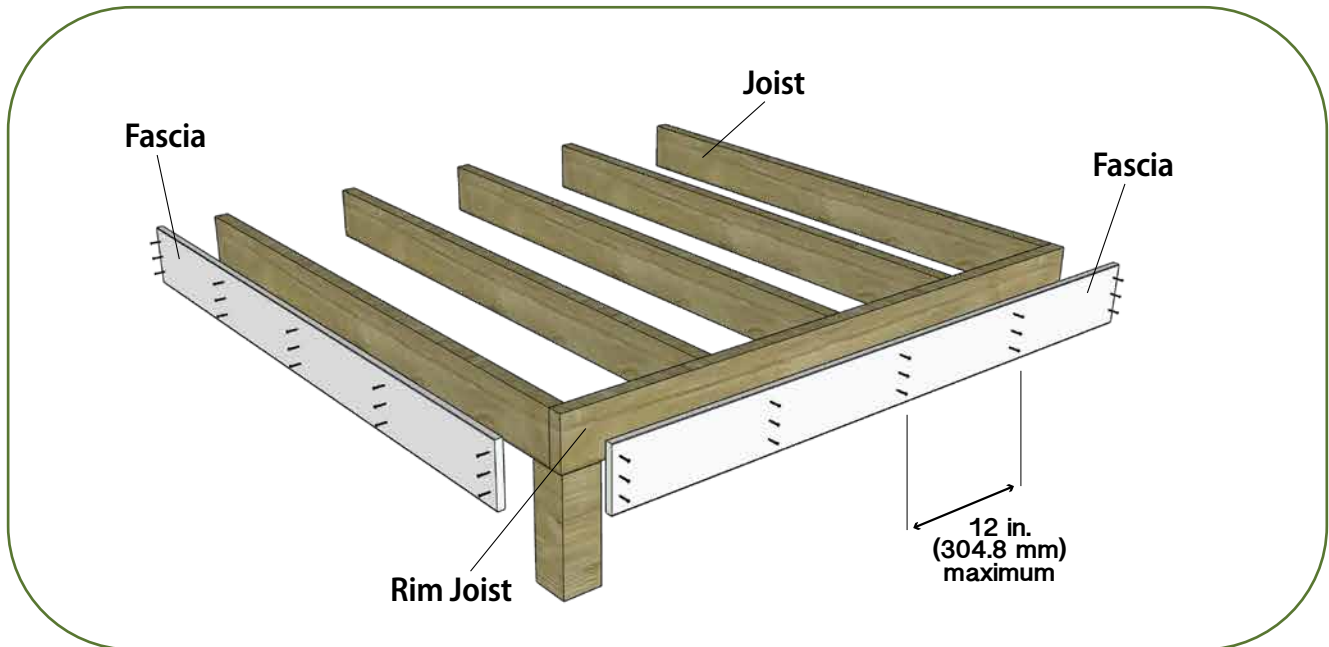

## Rooftop and Sleeper Deck Systems - Pressure Treated Framing

A sleeper system is a substructure between a solid surface and Sylvanix decking. Drainage, access, and airflow are critical. Water must be able to flow through and away from the underneath the deck.

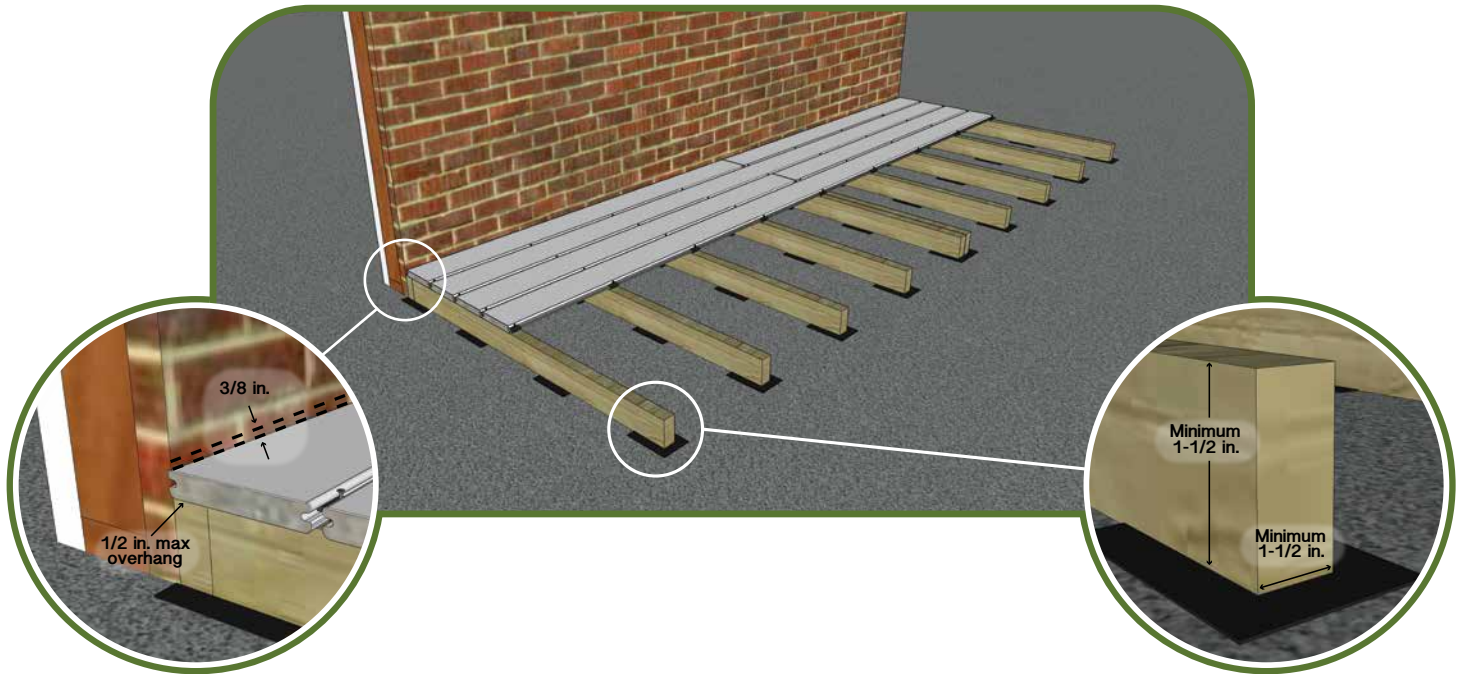

1. Building-code-approved structural material is recommended to be used for the supports.
2. This system should be secured and not allowed to float. The sleepers must be attached in a way that secures the framing system from movement.
3. The sleeper system must be level and even. Any uneven areas of the framing will transfer to the Sylvanix decking surface, resulting in uneven or warped decking.
4. The supports must run the direction of the pitch of the roof to facilitate proper drainage. Allow for adequate space for debris and water to exit roofing system.
5. For commercial applications, consult a local building code official and or Architect for specific construction details.

**NOTE:** In sleeper applications make sure that screw lengths will not cause penetrations into any roofing or waterproof membranes.

**NOTE:** Any deviation from these recommendations could void Sylvanix Decking warranty.