

DrySpace™ Installation Guide



| | |
|--|---|
| General Information | 2 |
| Tools & Materials Needed | 2 |
| Determine the Corect Installation Pitch..... | 3 |
| Ledger F-Bracket Installation..... | 3 |
| Install Combo Brackets | 3 |
| Custom Double and Triple Combo Brackets..... | 3 |
| V-Panel Installation | 4 |
| Best Practice Recommendation | 4 |
| Gutter Installation | 4 |

TimberTech DrySpace should be installed in accordance with the local building codes and the installation guidelines included below. TimberTech accepts no liability or responsibility for the improper installation of this product. Failure to install TimberTech DrySpace in accordance with applicable building codes and this Installation Guide may lead to personal injury, affect product performance and void the product warranty.

TimberTech
894 Prairie Avenue
Wilmington, OH 45177
timbertech.com
1.800.307.7780

DrySpace is a revolutionary deck drainage system that collects the water that falls between the gaps in the planks and channels it away from the space below.

Important Information

- DrySpace is designed for decks with 12" and 16" on center joist spacing. A 2x6 filler board can be installed to accommodate joist spacing up to 14" for the 12" on-center and 18" for the 16" on-center. The open space between on-center joists should not be more than 11" for the 12" on-center (**Fig. A1**), and no more than 15" for the 16" on-center (**Fig. A2**). **For decks with joist spacing greater than 14" on-center, the DrySpace kit for 16" on-center joists should be used.**
- Installation of DrySpace must stop a minimum of 3' before the Fascia. This allows water to exit the DrySpace panel and provide for ventilation.
- **Never install DrySpace over a beam.**
- DrySpace should not be spliced to achieve longer runs. Lapping the system could result in leakage. For runs over 16', terminate DrySpace at the mid support beam. More information can be found at timbertech.com/DrySpace
- DrySpace should not be enclosed with a wall around the outside perimeter of the deck. It is not intended to be a water proof roof system.
- **DrySpace must be installed so that water runs away from the house.**
- Appliances, such as dryers and exhaust fans, should not be vented into the space between the deck surface and DrySpace panels.
- Installation is easiest with two people.

DrySpace Kits

| Kit 12" Ledger | Length | Lbs. Unit | O.C. V-Panels | | Combo Brackets | | F-Bracket |
|-------------------|--------|--------------|------------------|-----|-------------------|-----|-----------|
| | | | 12" | 16" | 12' | 16' | |
| 12" O.C. | 12' | 504 | 6 | | 7 | | 1 |
| 16" O.C. | 12' | 546 | | 6 | 7 | | 1 |
| 16" O.C. | 16' | 738 | | 6 | | 7 | 1 |

Also Available in Bulk

| Components | Length | Qty./ Carton | Lbs./ Carton |
|----------------------|--------|-----------------|-----------------|
| 12" O.C. Panels | 12' | 12 | 53 |
| 12" O.C. Panels | 16' | 12 | 70 |
| 16" O.C. Panels | 12' | 12 | 74 |
| 16" O.C. Panels | 16' | 12 | 98 |
| Combo Brackets | 12' | 7 | 43 |
| Combo Brackets | 16' | 7 | 57 |
| Ledger F-Brackets | 12' | 20 | 50 |
| Double Combo Bracket | 16' | 5 | 48 |

Tools & Materials Needed

- Safety Glasses
- Square
- Utility Knife
- Pliers
- 1" Hot Dipped Galvanized Roofing Nails or 1" Deck Screws (for Treated Lumber)
- Chalk Line
- Two Putty Knives
- Butyl Rubber Tape
- Two Step Ladders
- Hammer
- Metal Snips
- Gloves
- Tin Flashing
- Tape Measure

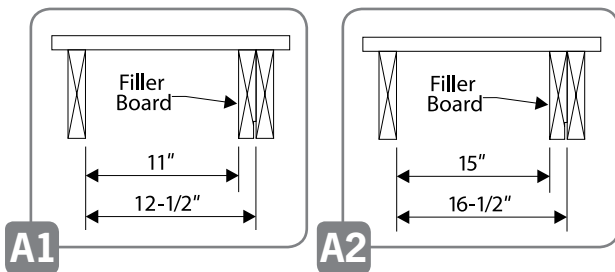

For Decks With 12" and 16" On-center Joist Spacing

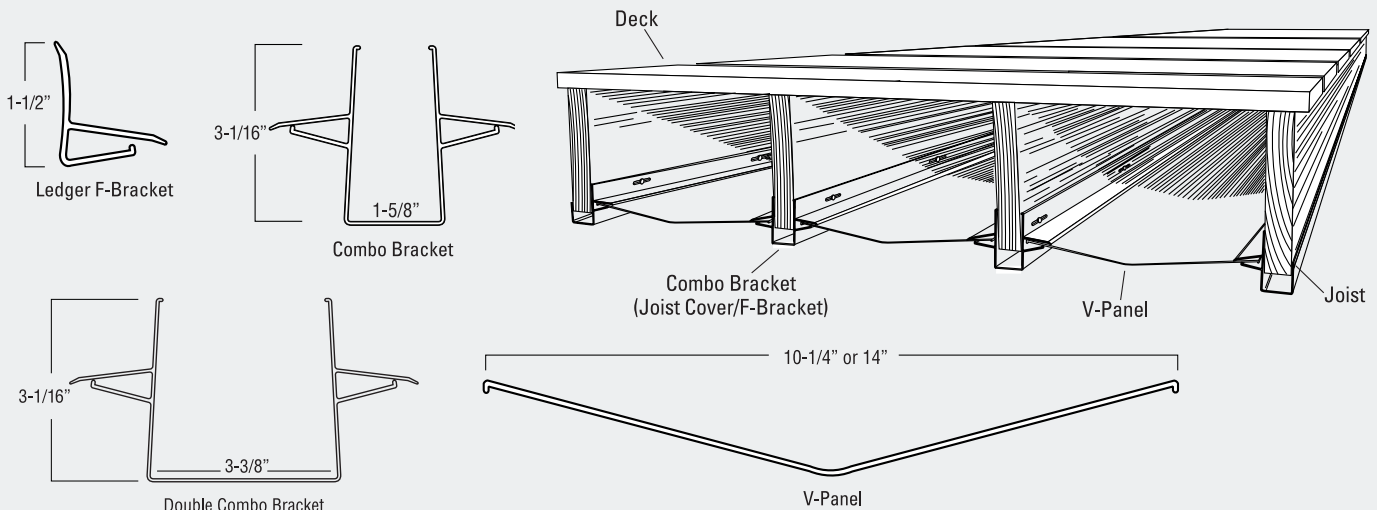

Visit www.timbertech.com/installation to view TimberTech installation videos.

Determine the correct installation pitch

DrySpace™ must be installed with a pitch of 1/8" per foot (Fig. B). Mark the correct pitch on each side of the joist with a chalk line. Measure from the bottom of the joist (Fig. C). With one end of the combo bracket seated against the joist, the top of the downstream end should sit at dimensions A in Fig. C. The pitch must be directed away from the house.

Ledger F-Bracket installation

Cut the Ledger F-Bracket 1/4" shorter than the joist opening. Measure 1-1/2" from the bottom of the joist (Fig. E); then fasten the Ledger F-Bracket to the ledger board by driving 1" hot dipped galvanized (meet ASTM A 153 class D are acceptable) roofing nails (or deck screws) in the center of the nail slots. Do not overdrive the fastener, but make sure the Ledger F-Bracket is firmly secured.

Install Combo Brackets

NOTE: The Combo Bracket includes integral brackets on each side to insert and hold the V-Panel. Bracket must stop at beam.

- Measure bracket length, then cut the DrySpace Combo Bracket 1" shorter than the joist length. **NOTE: To ensure a straight clean cut, place a scrap piece of 2x4 wood inside the Combo Bracket. Cut with a miter saw (Fig. D).**
- Slide each DrySpace Combo Bracket over the joist bottom. Make sure the integral V-Panel Brackets on the outside of the Combo Bracket overlap the Ledger F-Bracket (Fig. E). Slide the lower leg of the Ledger F-Bracket into the Combo Bracket outside V-Panel Brackets. Align the top edge to the pitch chalk line.
- Nail the Combo Bracket in place with 1" hot dipped galvanized (meet ASTM A 153 class D are acceptable) roofing nails (or deck screws) in the provided nail slots. Nail both sides of the Combo Bracket. **NOTE: Nail tight, but don't overdrive the nail.**
- For double joists use DrySpace Double Combo Bracket and follow steps above. Outside Combo Bracket installation.
- For the two outside deck brackets, the outside integral V-Panel Bracket must be removed. Trim what will be the outside portion of the Combo Bracket by making a score line under the V-Panel Bracket with a utility knife (Fig. F), then snap off the section with the integral V-Panel Bracket (Fig. G). Install the trimmed Combo Bracket for the inside portion of the bracket (Fig. H). This piece can be trimmed with a piece of lumber.

NOTE: Refer to timbertech.com for installation recommendations for beams and ceiling fans.

Custom Double and Triple Combo Brackets

- Remove any nails or obstructions that might be in the bottom 1-3/4" of the doubled joist. Make a 1-1/2" deep saw cut along the entire bottom of the double joist (Fig. I). Trim what will be the inside leg of two Combo Brackets just below the brackets for V-Panel installation (Fig. J). **Note: Notch (with a utility knife) 1-1/2" of both Combo Bracket legs near each end. Notching the legs will help lock the combined Combo Brackets in the saw cut at both ends of the cut. Check the fit of the trimmed Combo Brackets.** Tape the two cut legs together with butyl rubber tape to create a sealed joint (Fig. K), then install into the saw cut. Make sure the Combo Brackets follow the chalk pitch line. Nail in place.

NOTE: Decks with a triple joist can be covered using the same method only with three Combo Brackets.

| Joist Length | Dimension "A" |
|--------------|---------------|
| 6' | 2-1/4" |
| 8' | 2" |
| 10' | 1-3/4" |
| 12' | 1-1/2" |
| 14' | 1-1/4" |
| 16' | 1" |

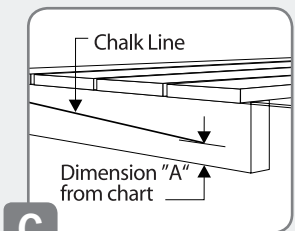

B

C

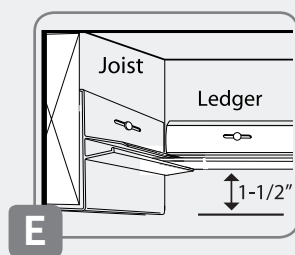
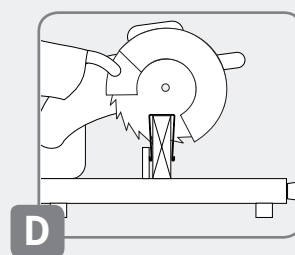

D

E

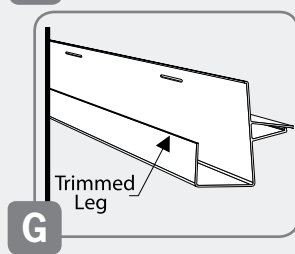
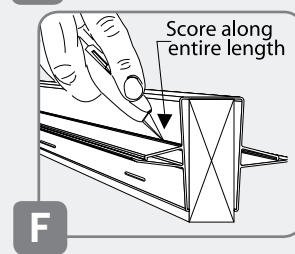

F

G

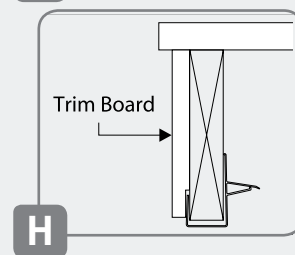

H

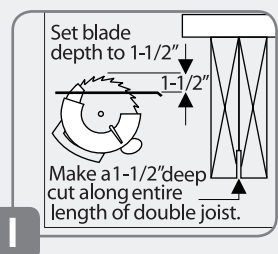

I

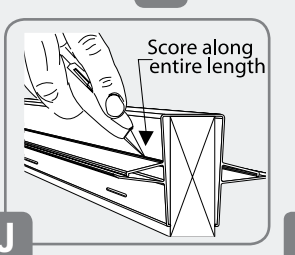

J

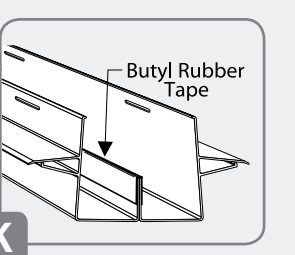

K

- Apply butyl rubber tape (**Fig. L**) to the following areas:
 - 1) **Corners where the F-Brackets overlap**
 - 2) **Along the top edge of the Ledger F-Bracket making sure to cover the F-Bracket nail slots**

V-Panel installation

- Measure, then cut each V-Panel 3" shorter than the joist to allow for drainage. **Note: To prevent water from running back up the bottom side of the panel and Combo Bracket, crimp the drainage ends of the V-Panel and Combo Bracket downward with pliers (Fig. M).**
- First install the V-Panel that will be anchored in the Ledger F-Bracket by inserting one panel edge into one of the Joist Cover's outside brackets. Next flex the panel to insert the opposite edge into the other Combo Bracket, then push the rest of the V-Panel in place.
- To insert the V-Panel into the Ledger F-Bracket, place a putty knife in each corner where the Combo Bracket's outside bracket and Ledger F-Bracket overlap (**Fig. N**). Place a scrap piece of 2x4 lumber against the open edge of the V-Panel and tap with a hammer. **NOTE: The 2x4 protects the V-Panel edge from damage. V-Panels must stop at the beam.**
- To collect and drain away water an optional vinyl or aluminum gutter can be installed (**see Gutter installation**).

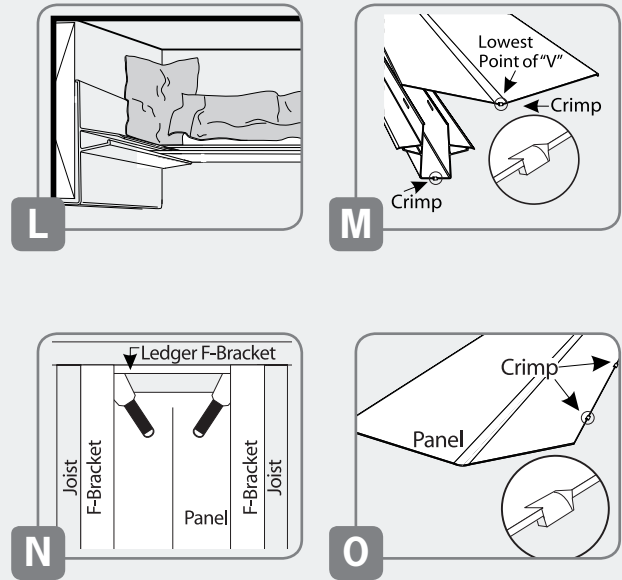

Faced with a smaller joist opening?

- If the joist opening (**Fig. A**) is less than 14-1/2", the V-Panel must be trimmed to 1/2" less than the joist opening dimension. Score one side of the V-Panel with a utility knife, then snap the extra panel width off. Should the joist opening be 12" or less, trim an equal amount of material from each side of the V-Panel.
- Use pliers to crimp the trimmed edges of the V-Panel downward every 6" along the cut line (**Fig. O**) to provide anchor notches when the V-Panel is installed in the Combo Bracket.

Best practice recommendation: Install tin flashing under first deck boards

For best results, install tin flashing under the length of the two deck boards closest to the house (**Fig. P**). This will assure that water is pushed out into the V-Panels below. Flashing must be compatible for use with treated lumber or installed with protective barrier. Consult your local building/home improvement center.

Gutter installation

An optional gutter and downspout can be installed with DrySpace™. Gutters must be installed at support beams to collect water from the V-Panels. Each project will have different requirements. The most common installations are shown (**Figs. Q and R**). A gutter can also be installed along the ledger board to collect water from between the ledger board and house and between the ledger board and joist ends. Standard vinyl or aluminum gutters and downspouts can be used. These are readily available at lumberyards.

NOTE: Gutter, downspout and accessories are not included with the DrySpace system.

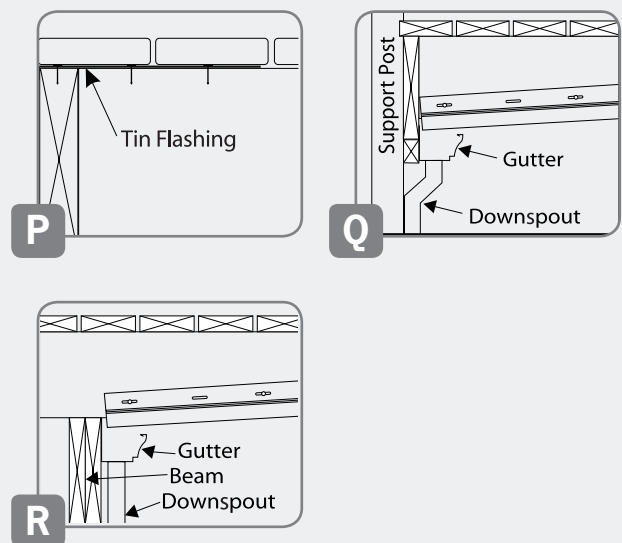

Crane Plastics Manufacturing's use of the mark DRYSPACE is with consent of DrySpace, Inc., in Cedar Rapids, Iowa. Crane Plastics Manufacturing and DrySpace Inc., are not affiliated in any way. Neither company warrants the goods or services of the other.